



# 目 录

<b>一、运输作业组织与管理模块</b> .....	<b>2</b>
.....	2
.....	5
.....	7
.....	10
.....	13
.....	16
.....	19
.....	22
.....	24
.....	30
<b>二、仓储与配送作业组织与管理模块</b> .....	<b>34</b>
.....	34
.....	40
.....	46
.....	52
.....	58
.....	63
.....	70
.....	76
.....	82
.....	88
.....	94
.....	98
.....	103
.....	108
.....	113
.....	118
.....	125
.....	131
.....	137
.....	143
<b>三、国际物流作业组织与管理模块</b> .....	<b>150</b>
.....	150
.....	152
.....	155
.....	158
.....	161
.....	164
.....	166
.....	168
.....	172

.....	175
.....	177
.....	179
.....	181
.....	184
.....	188
.....	190
.....	193
.....	195
.....	197
.....	199
.....	202
.....	204
.....	207
.....	208
.....	210
<b>四、 快递物流作业组织与管理模块.....</b>	<b>213</b>
.....	213
.....	216
.....	219
.....	224
.....	228
.....	231
.....	234
.....	238
.....	242
.....	246
.....	249
.....	252
.....	255
.....	258
.....	261
.....	264
.....	267
.....	271
.....	274
.....	277
.....	280
.....	283
.....	287
.....	290
.....	293

湖南商务职业技术学院物流管理专业学生技能考核题库

## 一、运输作业组织与管理模块

○

○

○

--	--	--

○

10000

4

6000

15

○

--	--	--	--	--

## ( ) 任务描述

○

:

○

○

4

10

5000

300000

15



○

20

/								
/								
			kg	m <sup>3</sup>				
□ □				□ □				
□ □								
						□ □ □ □		
	3							

○

15



( ) 任务描述:

1‰

- 
- 
- 

20

15









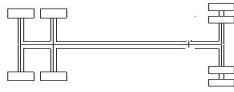
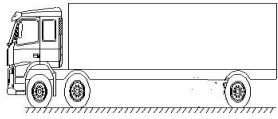

9.6



9.6

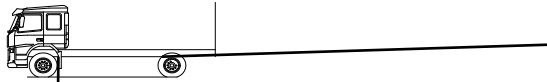

( ) 任务描述:



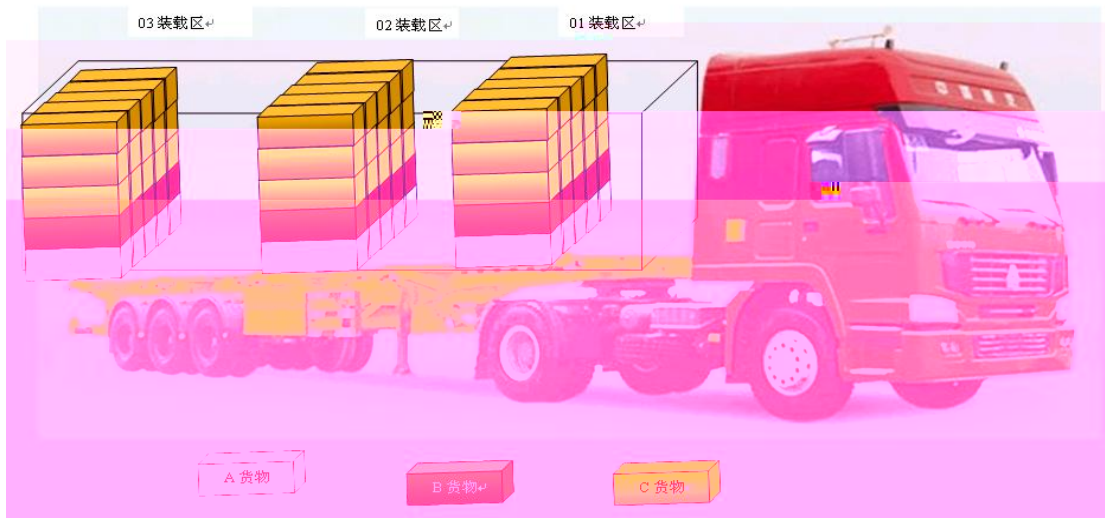

○

○

○

○

○



( ) 任务描述

○

15

○

D

1.65 /

347 /

4‰

10

25 /

12

250 /

20

○

20

D

/									
/									
*	*	*	* kg	* m <sup>3</sup>	*	*	*	*	
<input type="checkbox"/> <input type="checkbox"/>			<input type="checkbox"/> <input type="checkbox"/>						
<input type="checkbox"/> <input type="checkbox"/>									
*						<input type="checkbox"/> <input type="checkbox"/> <input type="checkbox"/> <input type="checkbox"/>			
	3								

○

D

15

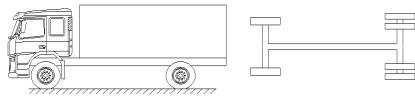
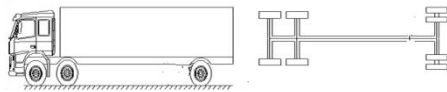
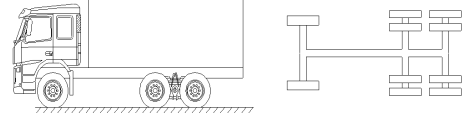
	1	4X2	
			
			

○

10

**2**

**3**

60

**4**

2

100

20%

80%

1



( ) 任务描述





1 4X2

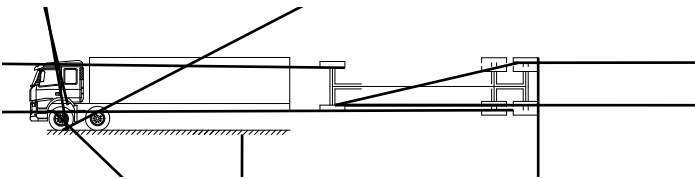
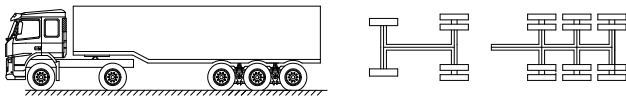
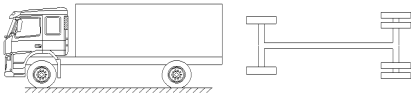







**( ) 任务描述**

○

○

○

○

○





( ) 任务描述

( ) ( )

Marks & Nos.	Descriptions	NO.of Packages ( )	Measurement ( )	Gross Weight KGS	Net Weight KGS	Total Price USD
AL DAH	CLEANING BALL	3500	53CMX21CMX15CM 0.0167M3/	12kg/	11kg/	1000

( )  
 ( )  
 ( )  
 ( )  
 ( )

THC TERMINAL HANDLING CHARGE	USD100/20GP USD150/40GP USD150/40HQ	
ORC ORIGIN RECEIPT CHARGE	USD190/20GP USD310/40GP USD310/40HQ	THC
BAF Bunker Adjustment Factor	USD394/20GP USD 788/40GP USD 788/40HQ	
AMS America manifest system	USD25/	
DHF Document handling fee	USD50/	
SLF SEAL FEE,	USD50/20GP USD 30/40GP USD 30/40HQ	
PSS:Peak Season Sucharges	USD30/20GP USD 30/40GP USD 30/40HQ	



( )				



Sailing Schedule from : Shenzhen,Shenzhen,Guangdong,China	
To : Los Angeles,Los Angeles,CA,United States	
Origin City : Shenzhen,Shenzhen,Guangdong,China	CY/DOOR
Destination City : Los Angeles,Los Angeles,CA,United States	CY/DOOR

序列号	航线	船名	航次	截关时间	装货港	预计离港时间	实际离港时间	卸货港
1	YPSW	YM UNISON	59E	2016-04-22 17:00	Yantian	2016-04-25		Los Angeles
2	SEA	NORTHERN JAVELIN	002E	2016-04-23 12:00	Yantian	2016-04-27		Long Beach
3	AAS2	CMA CGM LIBRA	095TXE	2016-04-25 16:00	Yantian	2016-04-28		Long Beach
4	YPSW	YM UBIQUITY	22E	2016-04-29 17:00	Yantian	2016-05-02		Los Angeles
5	SEA	C SCL PUSAN	117E	2016-04-30 12:00	Yantian	2016-05-04		Long Beach
6	AAS2	CMA CGM COLUMBA	097TXE	2016-05-02 16:00	Yantian	2016-05-05		Long Beach
7	SEA	COSCO NINGBO	069W	2016-05-06 11:00	Yantian	2016-05-08		Long Beach
8	YPSW	YM JIREBY	50E	2016-05-06 17:00	Yantian	2016-05-09		Los Angeles
9	SEA	COSCO EXCELLENCE	027E	2016-05-07 12:00	Yantian	2016-05-11		Long Beach
10	AAS2	CMA CGM CENTAURUS	099TXE	2016-05-09 16:00	Yantian	2016-05-12		Long Beach
11	YPSW	YM MASCULINITY	32E	2016-05-13 17:00	Yantian	2016-05-16		Los Angeles
12	SEA	HONG KONG BRIDGE	039E	2016-05-14 12:00	Yantian	2016-05-18		Long Beach
13	AAS2	CMA CGM THALASSA	101TXE	2016-05-16 16:00	Yantian	2016-05-19		Long Beach

ach



COSCO CONTAINER LINES

干货箱



	箱体内部尺寸			箱体内容积及载重量		箱门开度尺寸	
	L	W	H	Cu	P	W	H
20'	5898	2352	2393	33.2	21740/28230#	2340	2280
40'	12032	2352	2393	67.7	26630	2340	2280
HC	12032	2352	2698	76.3	26520	2340	2585

冷藏箱



	箱体内部尺寸			箱体内容积及载重量	
	L	W	H	Cu	P
20'	5444	2284	2267	28.5	21135/27160#
40'	11583	2284	2250	58.7	26580
HC	11583	2286	2556	67.9	26380

开顶箱



	箱体内部尺寸			箱体内容积及载重量	
	L	W	P	Cu	P
20'	5900	2330	2337	32.6	21740
40'	12025	2330	2337	65.8	26410

○

○

( ) 实施条件

( ) 考核时量

60

( ) 评分细则

		20%	2	80%	100
1		1			
(80 )		20			
				5 5	
		15		3 2 3 2	2
		20		3	



		15			

( ) 任务描述

LX  
(computer parts)

DO

2014 10 7 20 00  
60X50X40CM 10kg/ 16000 /  
5

M	-45	+45	+100	+300	+500	+1000
500	32	23	19	18	17	16



*Shipper("The Customer")		Mawb No:	Hawb No.:
*Consignee			
Notify Party Tel:                      Fax:			
Name of Carrier	*Departure Airport	*Airfreight Charges: <input type="checkbox"/> Prepaid <input type="checkbox"/> Collect	Other Charges: <input type="checkbox"/> Prepaid <input type="checkbox"/> Collect
*Destination	Country of Origin(Goods):		

*Marks and Kind of Packages :Description of Goods		*Gross Weight	*Measurement	
Specify Currency	Declared Value for Customs	Declared Value for Carriage	Insurance Amount	Shipper's C.O.D
Special Instructions: Agree Rate:		We hereby guarantee payment of all freight collect charges due to the forwarders or to the carrier. If the shipment is abandoned ,refused by consignee. Returned at our request, confiscated by the customs or for any other reason can't be delivered within a reasonable time		
Documents accompanying Airway Bill: <input type="checkbox"/> Packing List <input type="checkbox"/> Certificate of Origin <input type="checkbox"/> Commercial Invoice <input type="checkbox"/> Consular Invoice		Signatory's Name in Block Letters:		
Received the above shipment for: By:		Signature and Stamp: Date: (Month/Day/Year)		

○

○

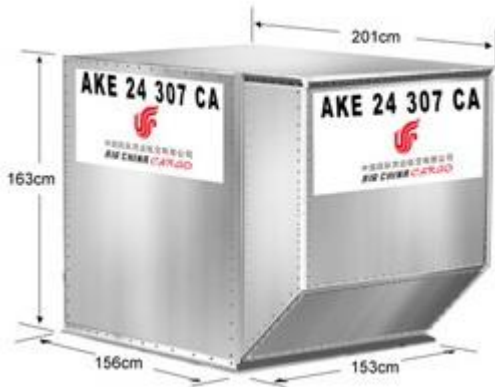

○

○

( ) 实施条件



(80 )		20			
		5		5	10
		15			
		20			10 5
				10	



1 2

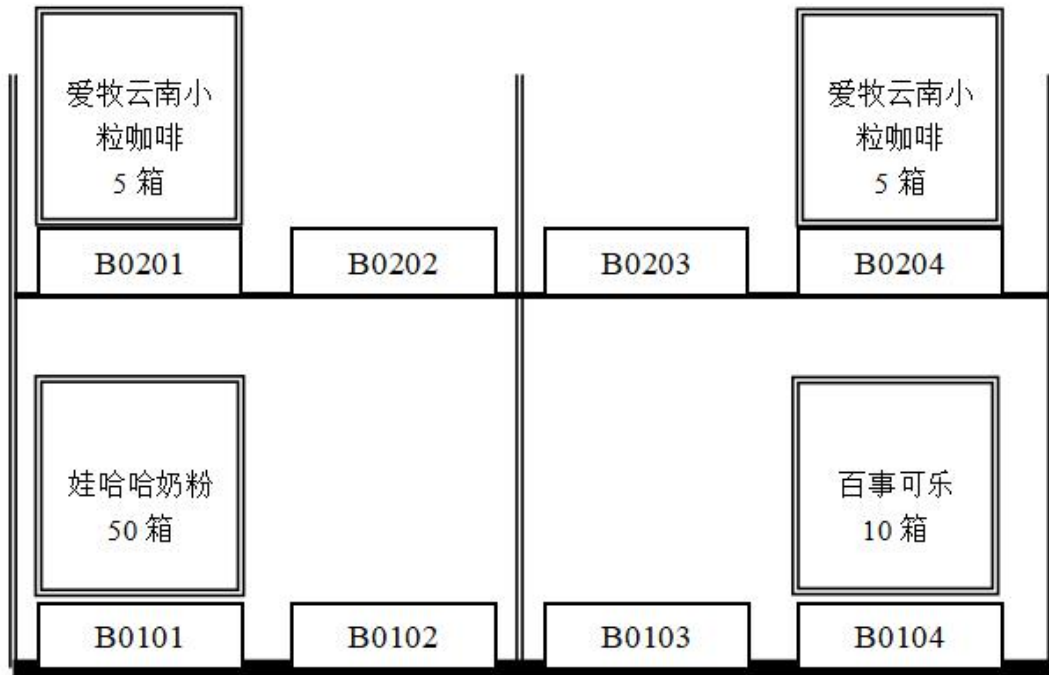
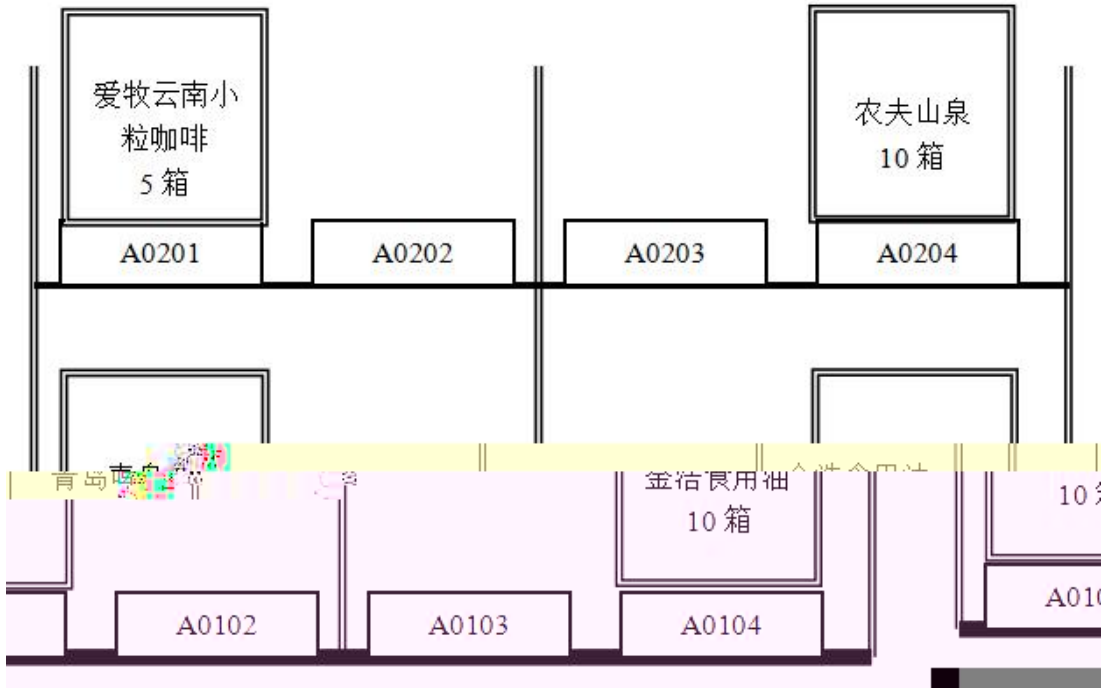

# 产品运输单

HD1011160001

			50	100ml*5	50		
			40	310ml	40		
3			20	100ml	20		

- 
- 
- 
- 
- 
- 
- 
-



	1	
	2	1

	5		2	1
	10		2	0
	5		2	1
<b>80</b>	10	ABC	6	2
	10		ABC	4
	10		10	3
	5		1	
	5		5	
	5		3	
	5		2	3
	5		2	3
			1	

	5		1 2 3	
	2	WMS	WMS 2	
	8		2 6 1	
	5		0.5 2 3	
	10		1 0.5 4 6 2 30mm	
	5	RF	RF 1	
	7		1 0.5 4 3 1 150mm	
	3	RF	RF 3	





1 2

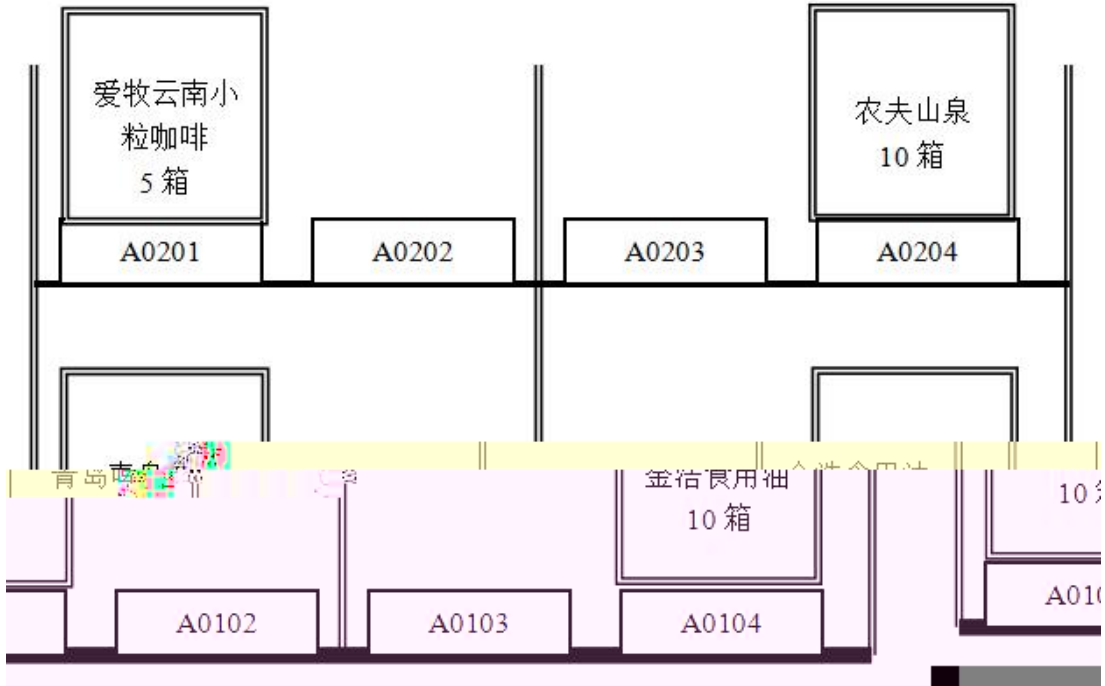

# 产品运输单

HD1011160001

				310ml	40		
			40		40		
3			20		20		

- 
- 
- 
- 
- 
- 
- 
- 

	1	

	2	1

	5			2	1
				2	
	10			1	
				2	
	10			1	2
				2	
	5			2	1
				2	
	5			2	1
<b>80</b>	10	ABC		6	2
			ABC	4	
	10			10	3
				1	
	5			5	
	5			3	
	5			2	3
5			1		
	5			2	
			1	3	

		2	WMS	WMS	2	
		8			6	1
					2	
		5			3	
				0.5	2	
		10			6	2
					4	
				1	0.5	
						30mm
		5	RF		RF	1
		7			3	1
					4	
				1	0.5	
						150mm
		3	RF		RF	3







1 2

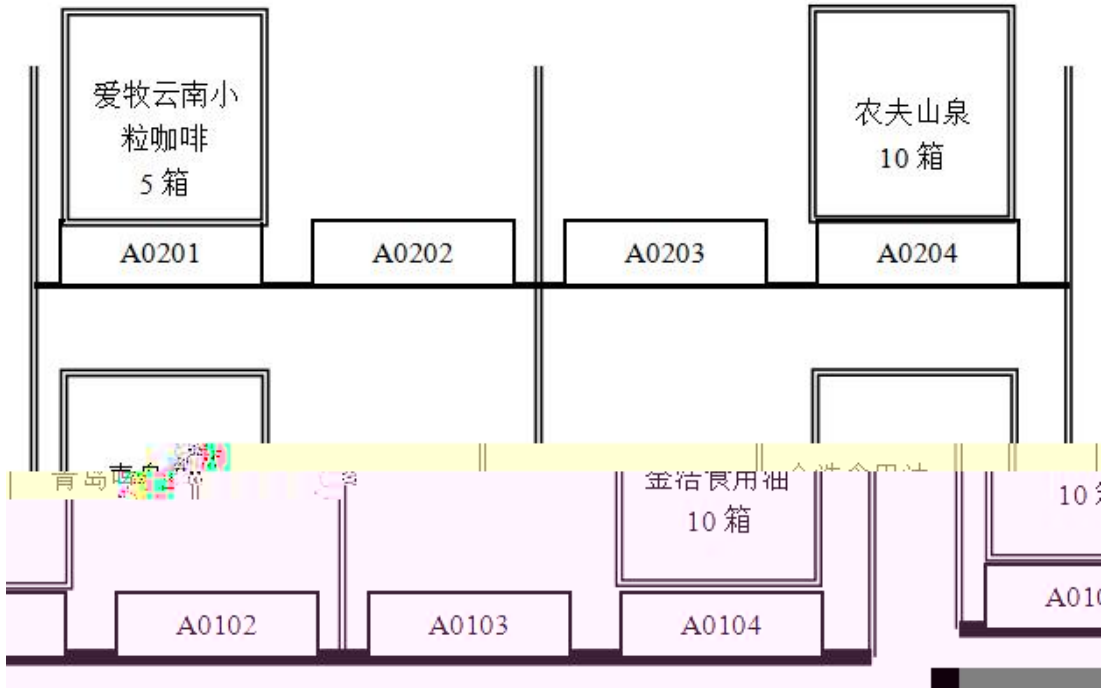

# 产品运输单

HD1011160001

			20	100ml*5	20		
			40	100ml	40		
			40	330ml	30		

- 
- 
- 
- 
- 
- 
- 
-

	2	1

	5		2	1
	10		2	0
	5		2	1
<b>80</b>	10	ABC	6	2
	10		ABC	4
	10		10	3
	5		1	
	5		5	
	5		3	
	5		2	3
5		1		
	5		2	3

		2	WMS	WMS	2	
		8			6	1
					2	
		5			3	
				0.5	2	
		10			6	2
					4	
				1	0.5	
						30mm
		5	RF	RF		1
					3	1
		7			4	
				1	0.5	
						150mm
		3	RF		RF	3





1 2



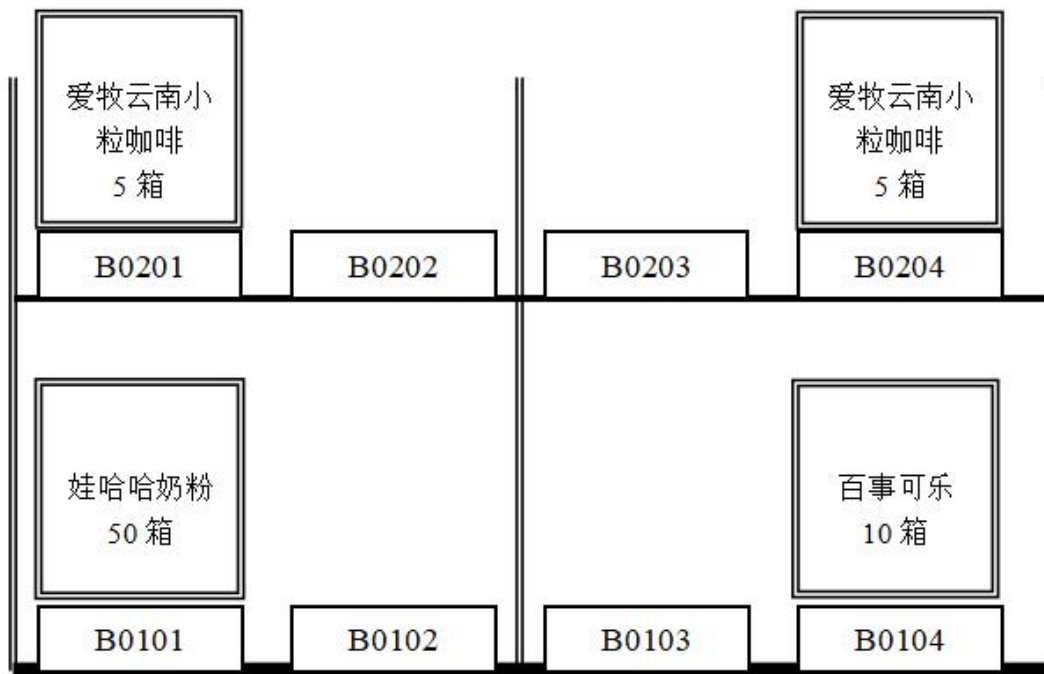
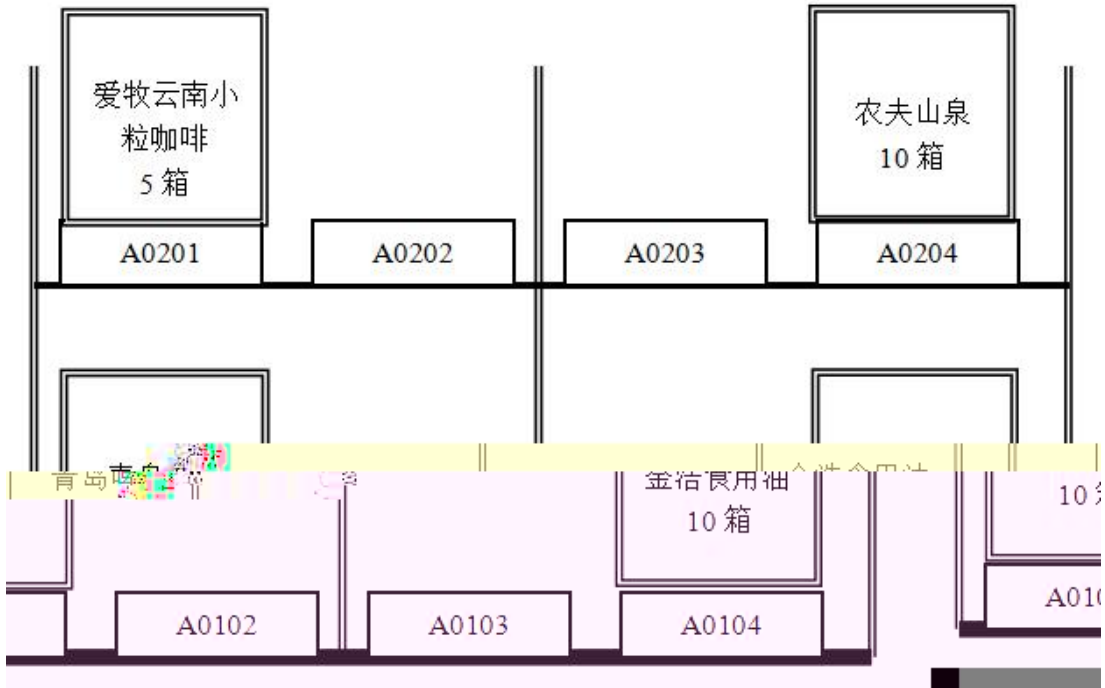

# 产品运输单

HD1011160001

			40	330ml	40		
			30	100ml*5	30		
			30	310ml	30		

- 
- 
- 
- 
- 
- 
- 
- 

	1	



		2	WMS	WMS	2	
		8			6	1
					2	
		5			3	
				0.5	2	
		10			6	2
					4	
				1	0.5	
						30mm
		5	RF		RF	1
		7			3	1
					4	
				1	0.5	
						150mm
		3	RF		RF	3





1 2

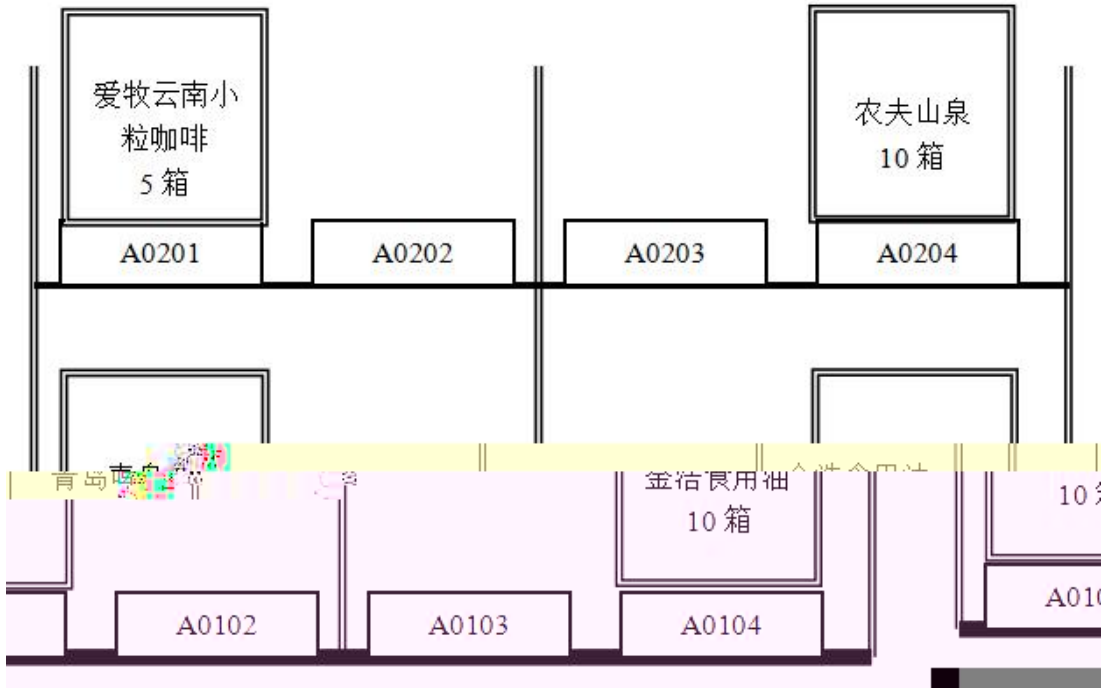

# 产品运输单

HD1011160001

			40	310ml	40		
			40	330ml	40		
3			20	100ml	20		

○

○

○

○

○



	2	1

	5			2	1
				2	
	10			1	
				2	
	5			2	1
				2	
<b>80</b>	10	ABC		6	2
			ABC	4	
	10			10	3
				1	
	5			5	
	5			3	
	5			2	
			2	3	
	5		1		
			2		
			1	3	

		2	WMS	WMS	2	
		8			6	1
					2	
		5			3	
				0.5	2	
		10			6	2
					4	
				1	0.5	
						30mm
		5	RF		RF	1
		7			3	1
					4	
				1	0.5	
						150mm
		3	RF		RF	3

2019 11 7

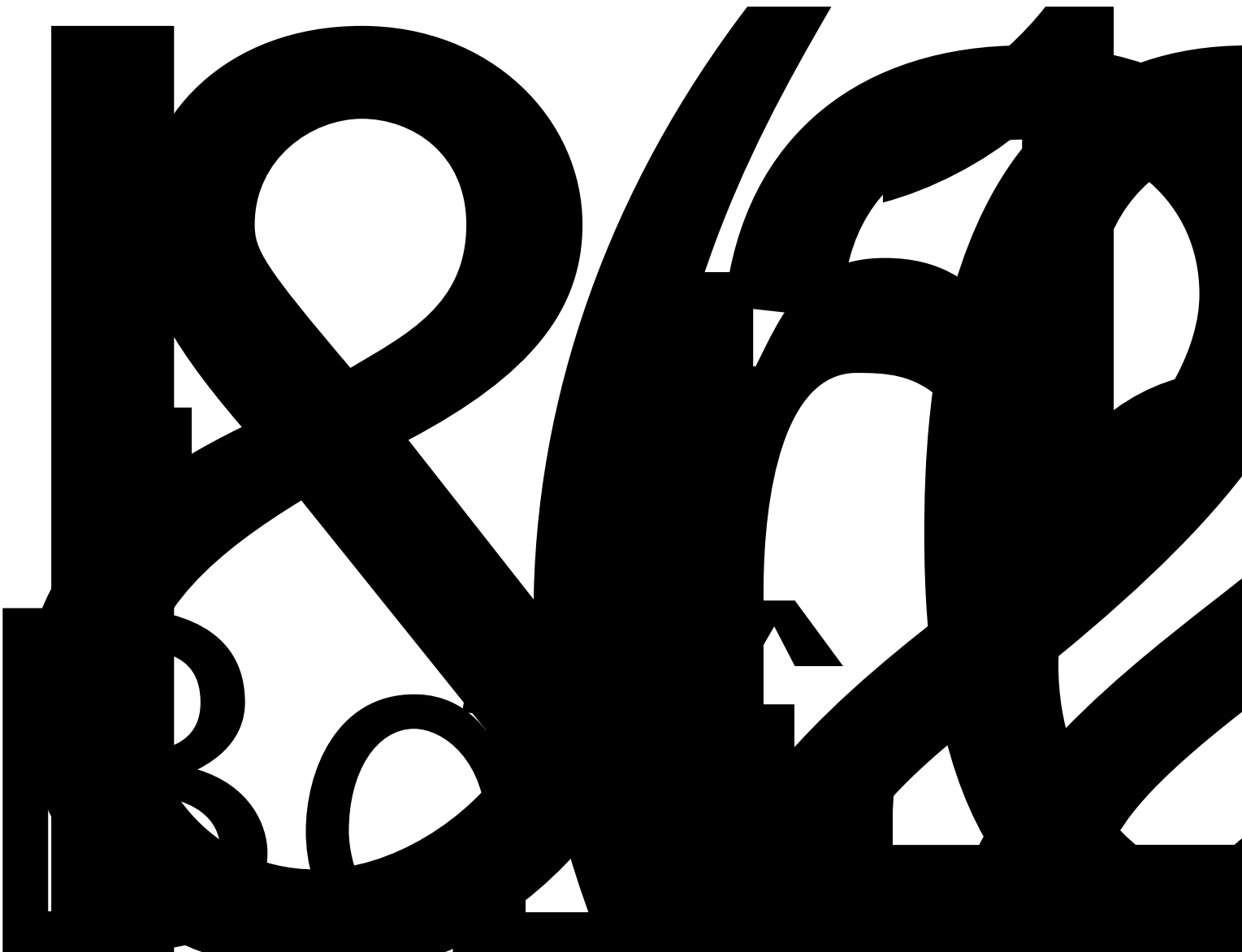

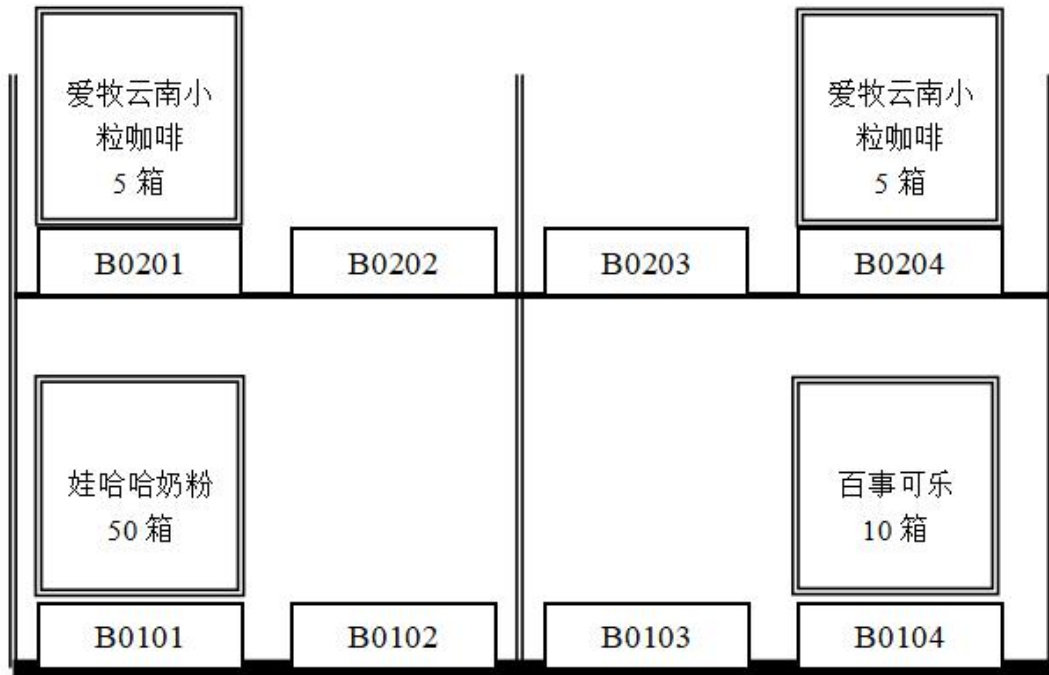
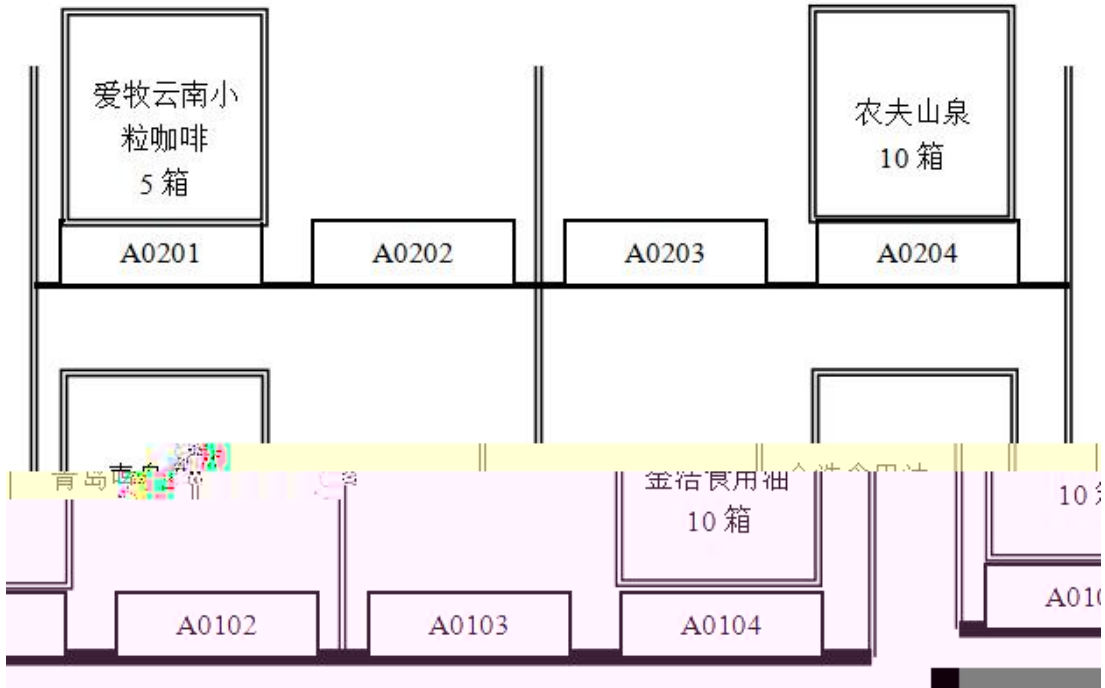
## 产品运输单

	2	1

	5			2	1
				2	
	10			1	
				2	
	5			2	1
				2	
<b>80</b>	10	ABC		6	2
			ABC	4	
	10			10	3
				1	
	5			5	
	5			3	
	5			2	3
	5		1		
			2		
			1	3	

		2	WMS	WMS	2	
		8			6	1
					2	
		5			3	
				0.5	2	
		10			6	2
					4	
				1 0.5		30mm
		5	RF		RF	1
		7			3	1
					4	
				1 0.5		150mm
		3	RF		RF	3







1 2

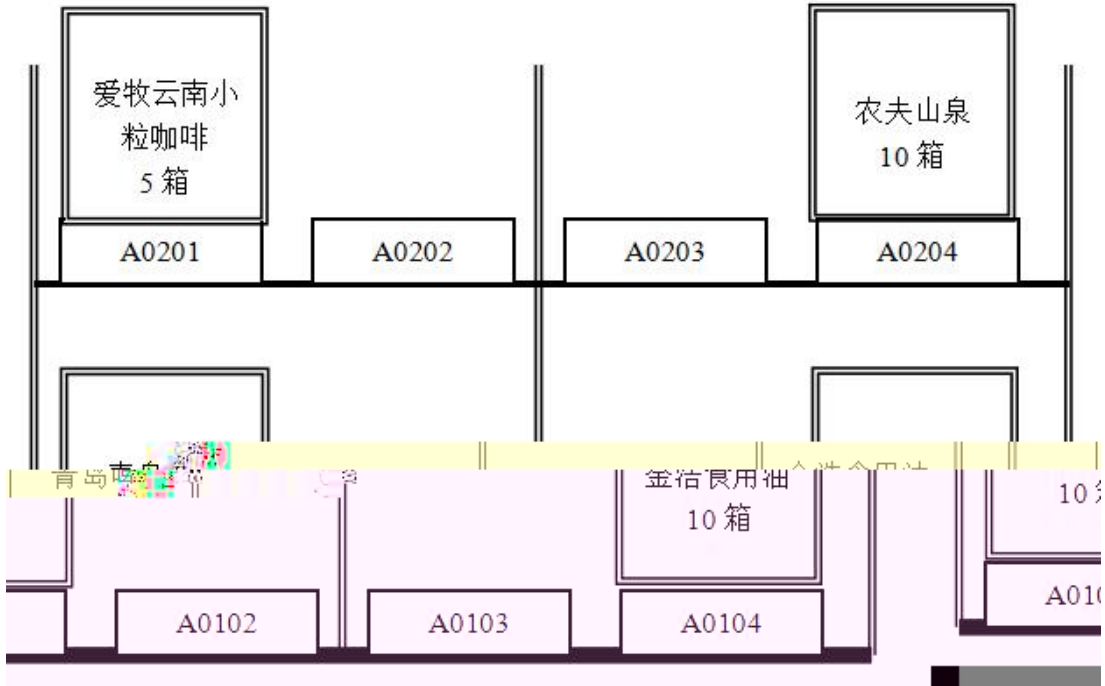

# 产品运输单

HD1011160001

				310ml	40		
			40		40		
3			20		20		

○

○

○

○

○

○

○

○

	1	

	2	1

	5			2	1
				2	
	10			1	
				2	
	10			1	2
				2	
	5			2	1
				2	
	5			2	1
<b>80</b>	10	ABC			2
			6		
			ABC	4	
	10			10	3
				1	
	5			5	
				3	
5			2		
			2	3	
5			1		
			2		
			1	3	

		2	WMS	WMS	2	
		8			6	1
					2	
		5			3	
				0.5	2	
		10			6	2
					4	
				1	0.5	
						30mm
		5	RF		RF	1
		7			3	1
					4	
				1	0.5	
						150mm
		3	RF		RF	3





1 2



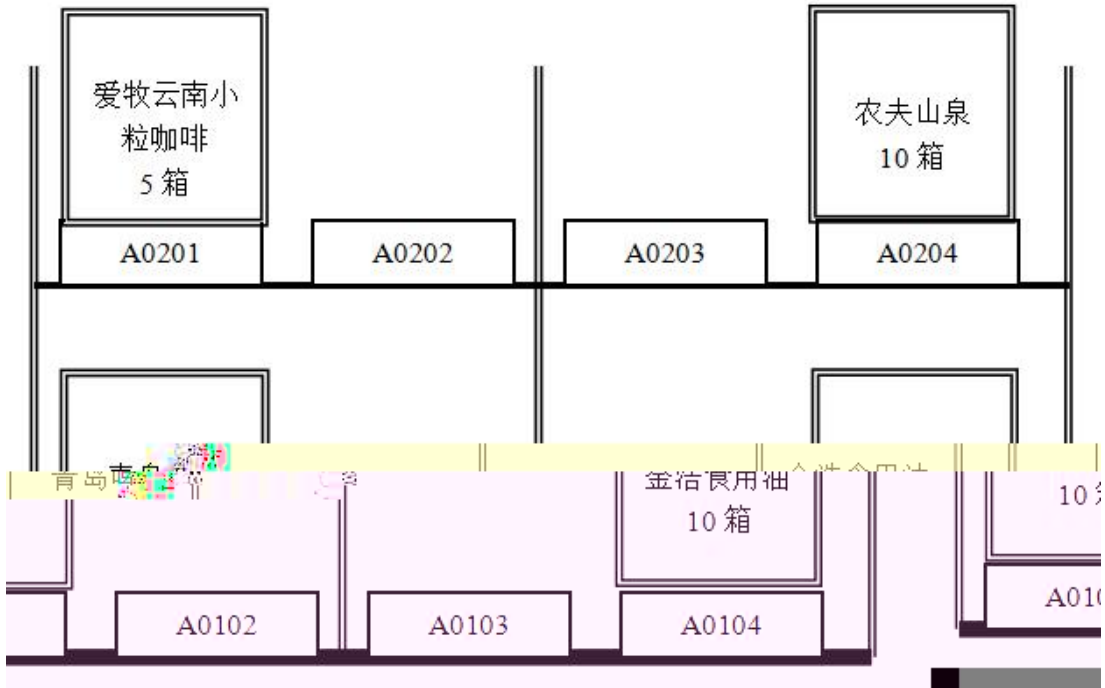

# 产品运输单

HD1011160001

			20	100ml*5	20		
			40	100ml	40		
			40	330ml	30		

- 
- 
- 
- 
- 
- 
- 
- 
- 

	1	

	2	1

	5		2	1
	10		2	0
	5		2	1
<b>80</b>	10	ABC	6	2
	10		ABC	4
	5		10	3
	5		1	
	5		5	
	5		3	
	5		2	3
	5		1	
	5		2	3
	5		1	
	5		2	3

		2	WMS	WMS	2	
		8			6	1
					2	
		5			3	
				0.5	2	
		10			6	2
					4	
				1 0.5		30mm
		5	RF		RF	1
		7			3	1
					4	
				1 0.5		150mm
		3	RF		RF	3





1 2

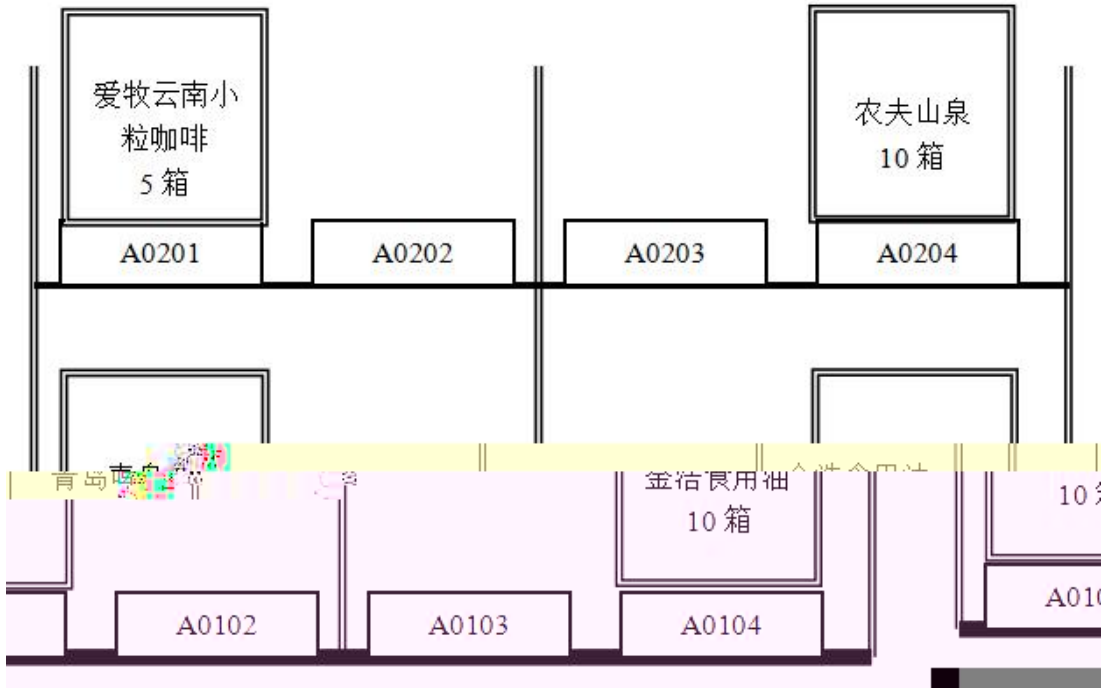

# 产品运输单

HD1011160001

			40	330ml	40		
			30	100ml*5	30		
			30	310ml	30		

- 
- 
- 
- 
- 
- 
- 
- 
- 

	1	



	2	1

	5			2	1
				2	
	10			1	
				2	
	10			1	2
				2	
	5			2	1
				2	
<b>80</b>	10	ABC		6	2
			ABC	4	
	10			10	3
				1	
	5			5	
	5			3	
	5			2	3
5			1		
	5			2	
			1	3	

		2	WMS	WMS	2	
		8			6	1
					2	
		5			3	
				0.5	2	
		10			6	2
					4	
				1	0.5	
						30mm
		5	RF		RF	1
		7			3	1
					4	
				1	0.5	
						150mm
		3	RF		RF	3





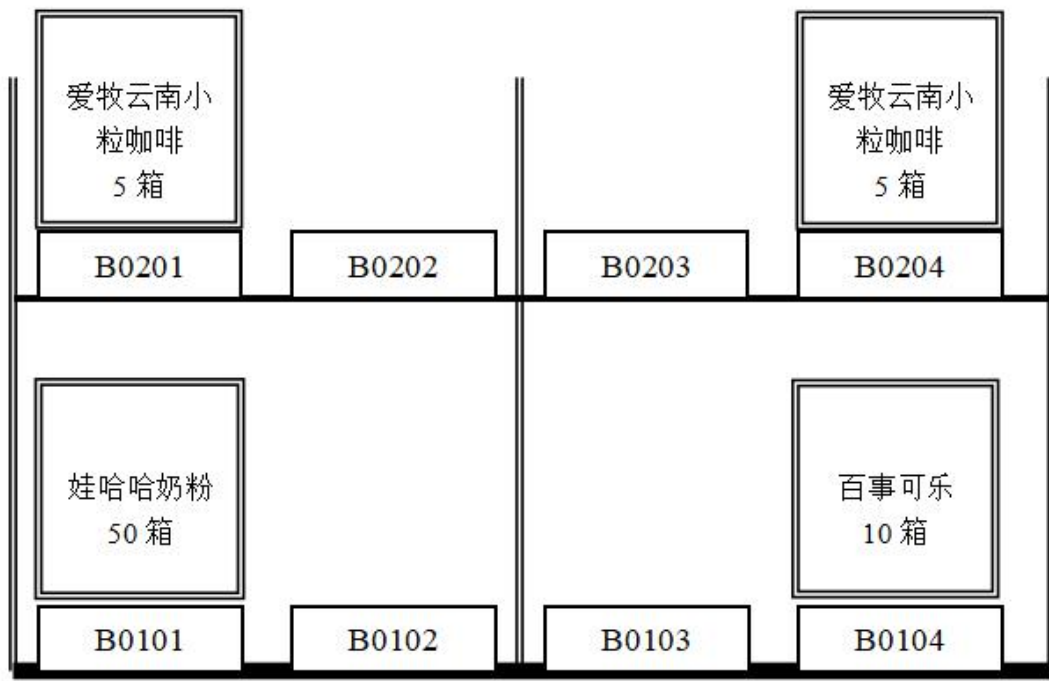
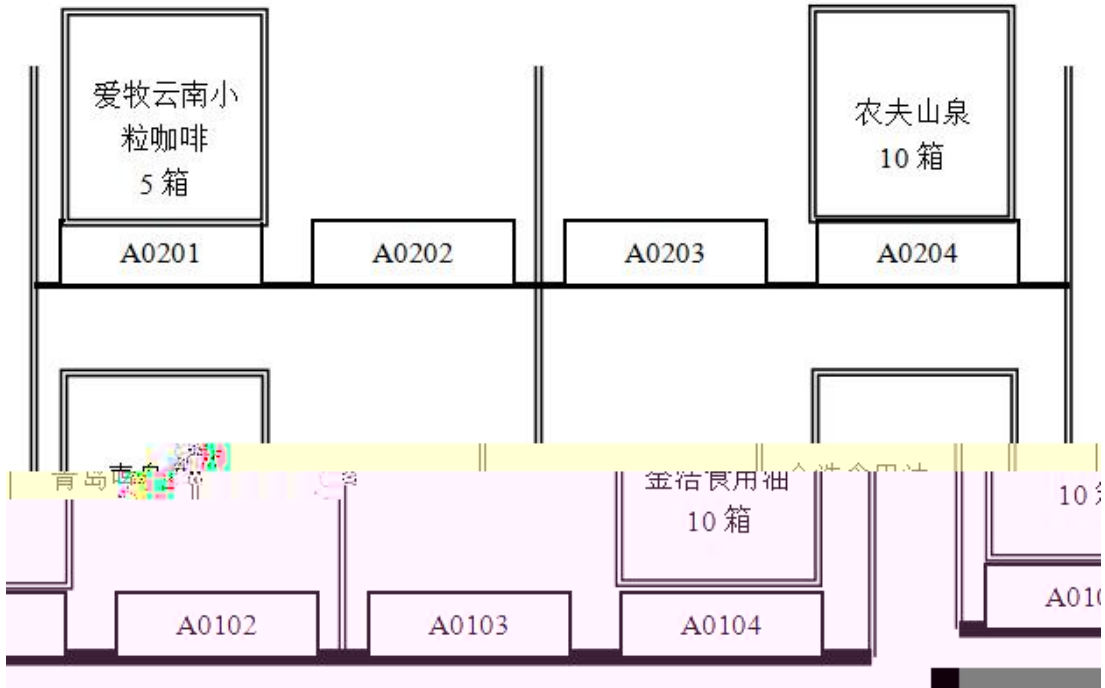

# 产品运输单

HD1011160001

			40	310ml	40		
			40	330ml	40		
3			20	100ml	20		

○

○

○

○

○

○

○

○

	1	

	2	1

	5			2	1
				2	
	10			1	
				2	
	5			2	1
				2	
<b>80</b>	10	ABC		6	2
			ABC	4	
	10			10	3
				1	
	5			5	
	5			3	
	5			2	3
5			1		
	5			2	
			1	3	

		2	WMS	WMS	2	
		8			6	1
					2	
		5			3	
				0.5	2	
		10			6	2
					4	
				1	0.5	
						30mm
		5	RF		RF	1
		7			3	1
					4	
				1	0.5	
						150mm
		3	RF		RF	3



○

---



---



---

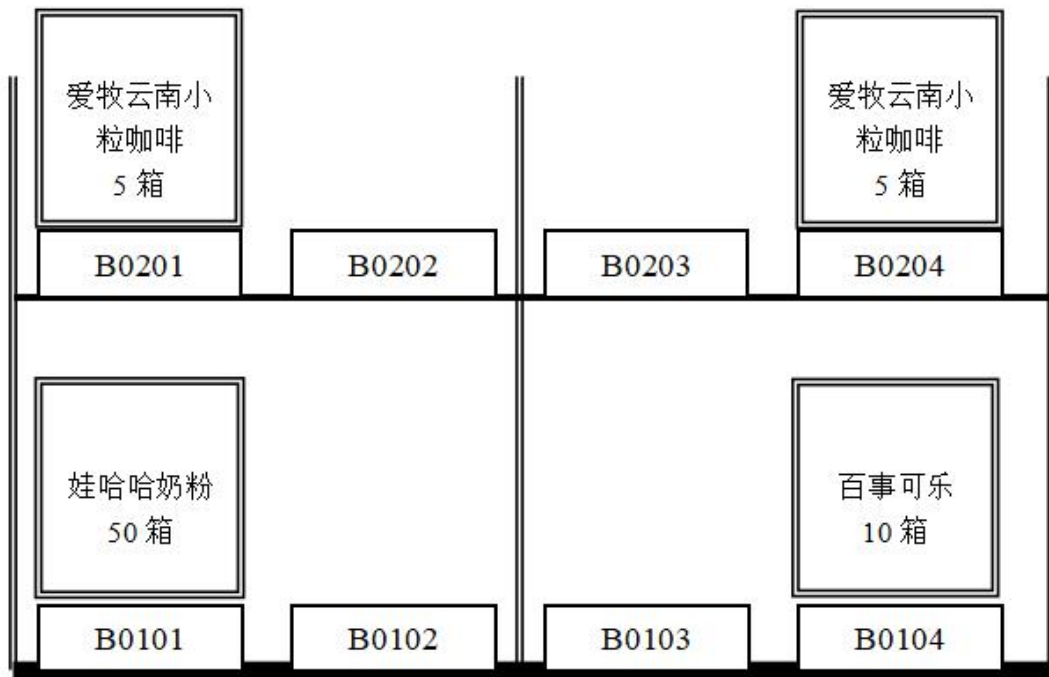
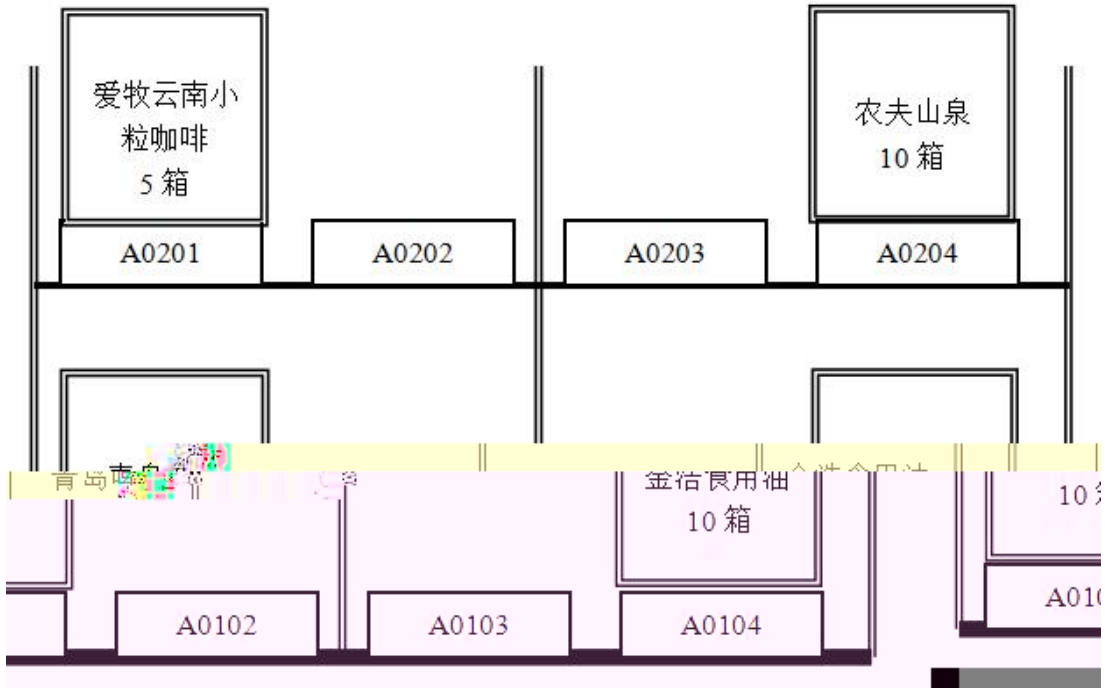

○  
km

○

		10		
		10		
		20		
		10		

---

--	--	--	--	--	--

---



---

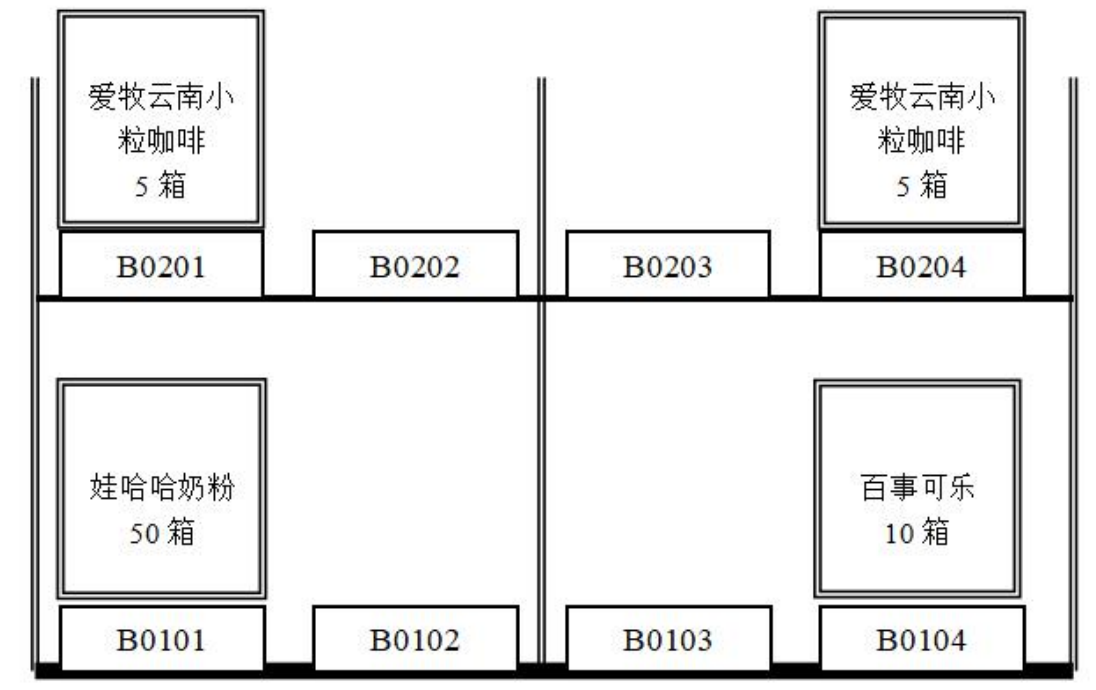
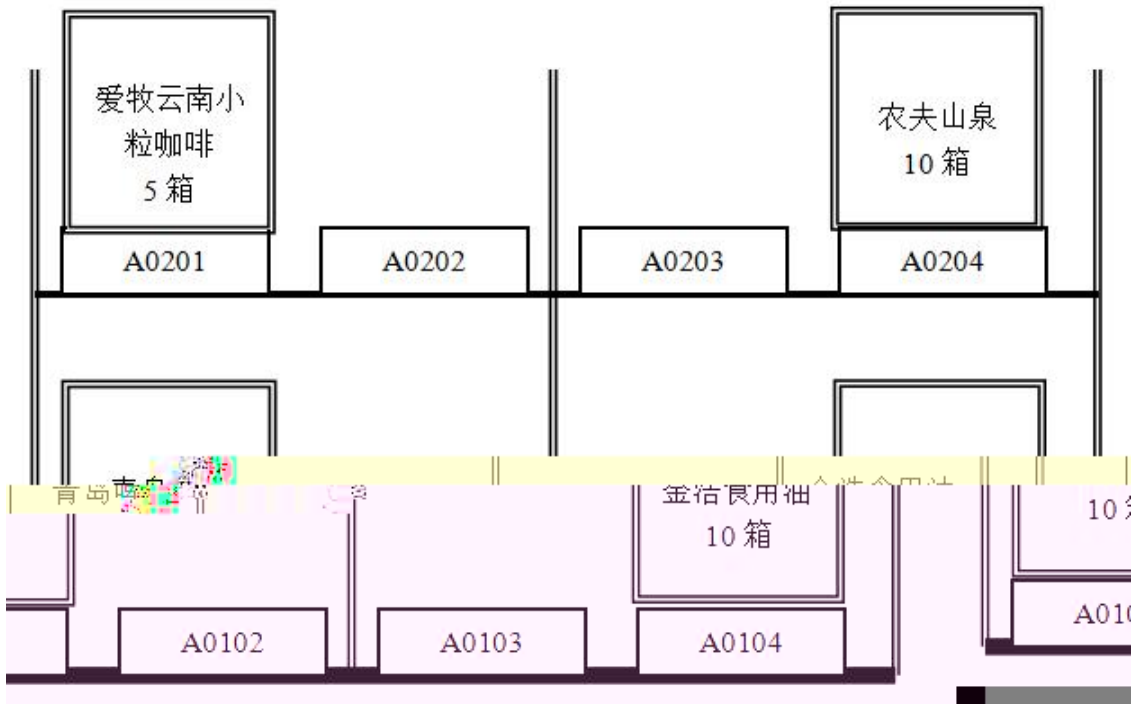

○  
km

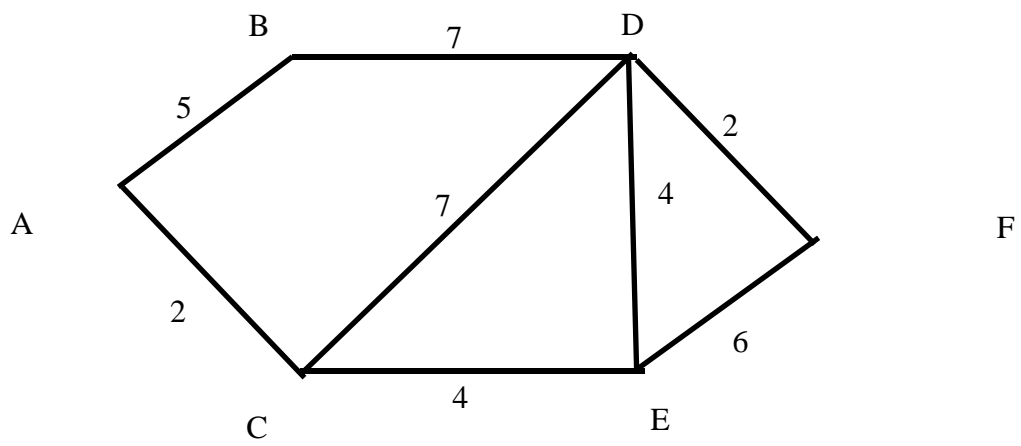

○



	5			0
	10			
	5			
	5			
	5			
	5			

15

10

10

---



---

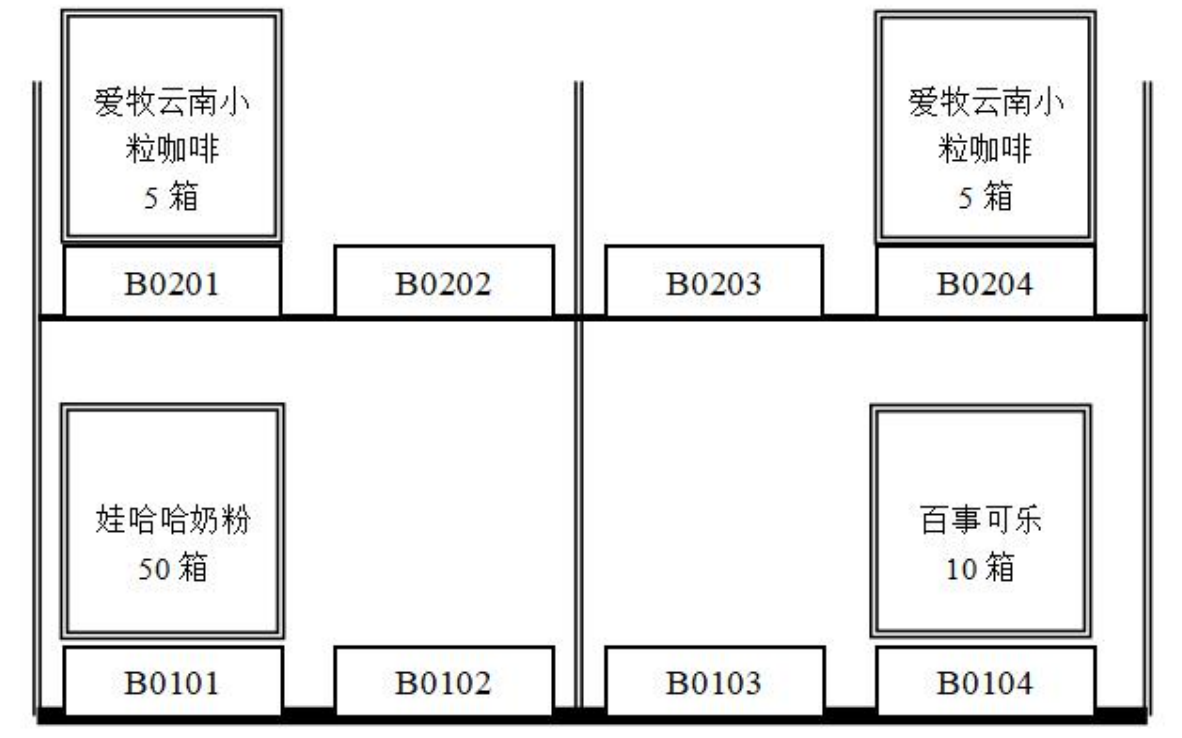
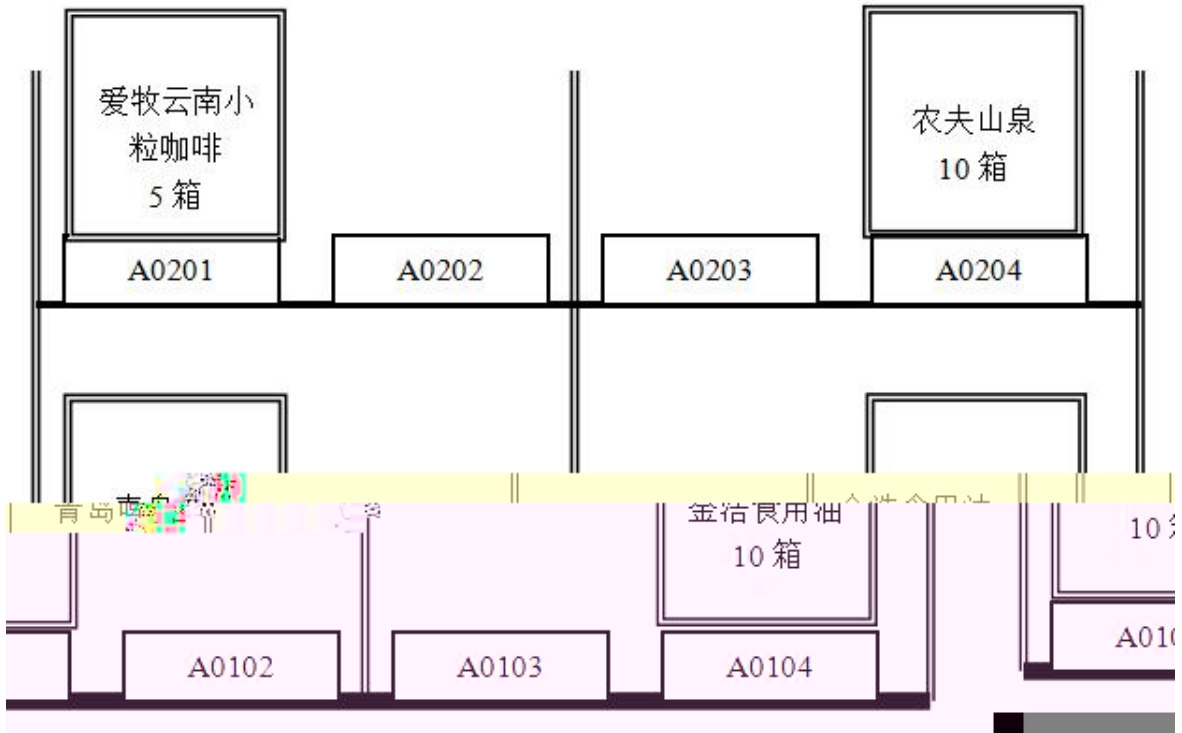

○  
km

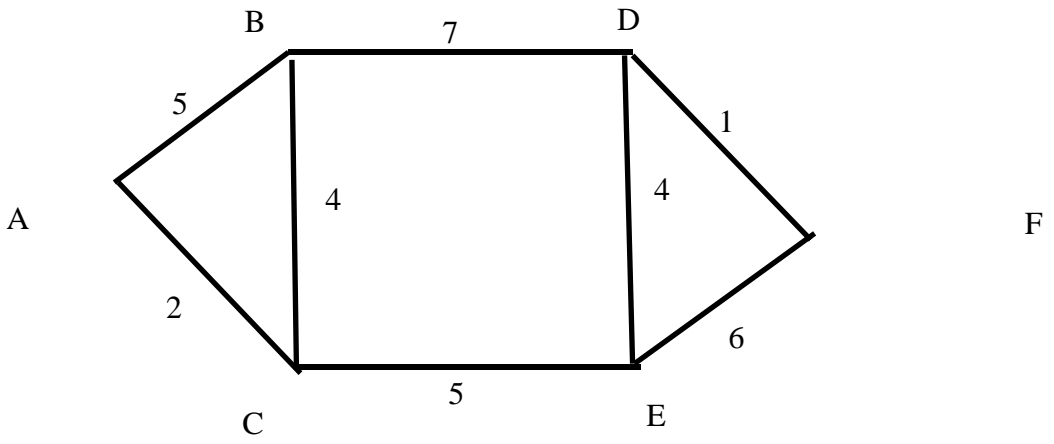

○

	5			0
	10			
	5			
		5		

		5		
		5		
		15		
		10		
		10		
		20		
		10		

**1**

---

		---	---		

---

		---	---		

---



---      ---



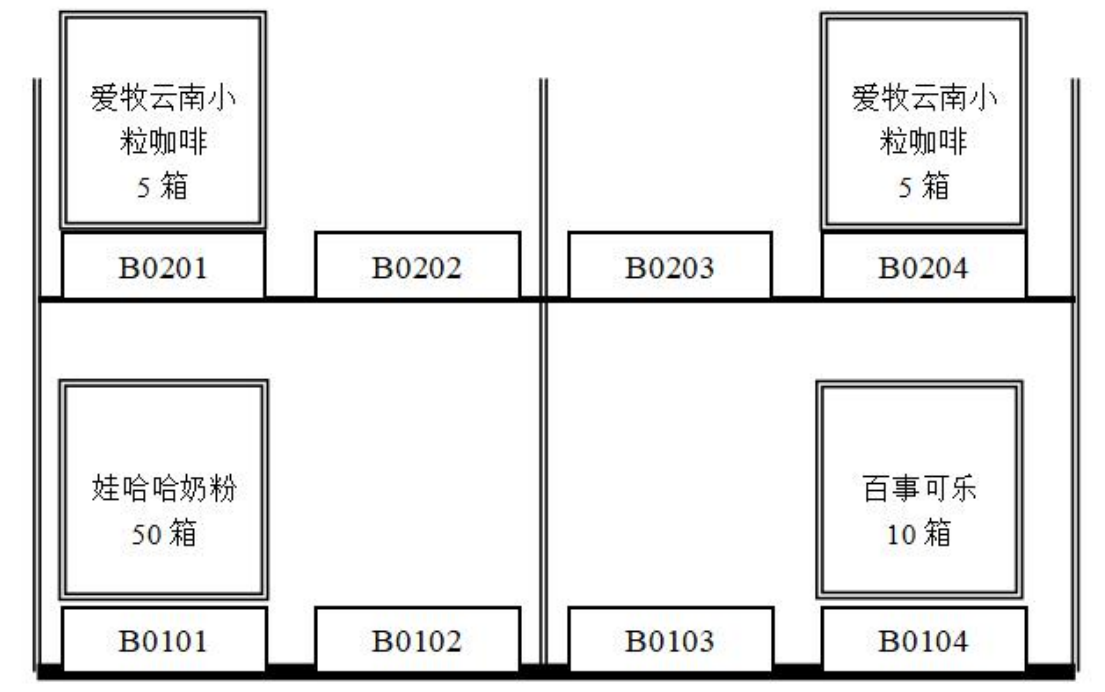
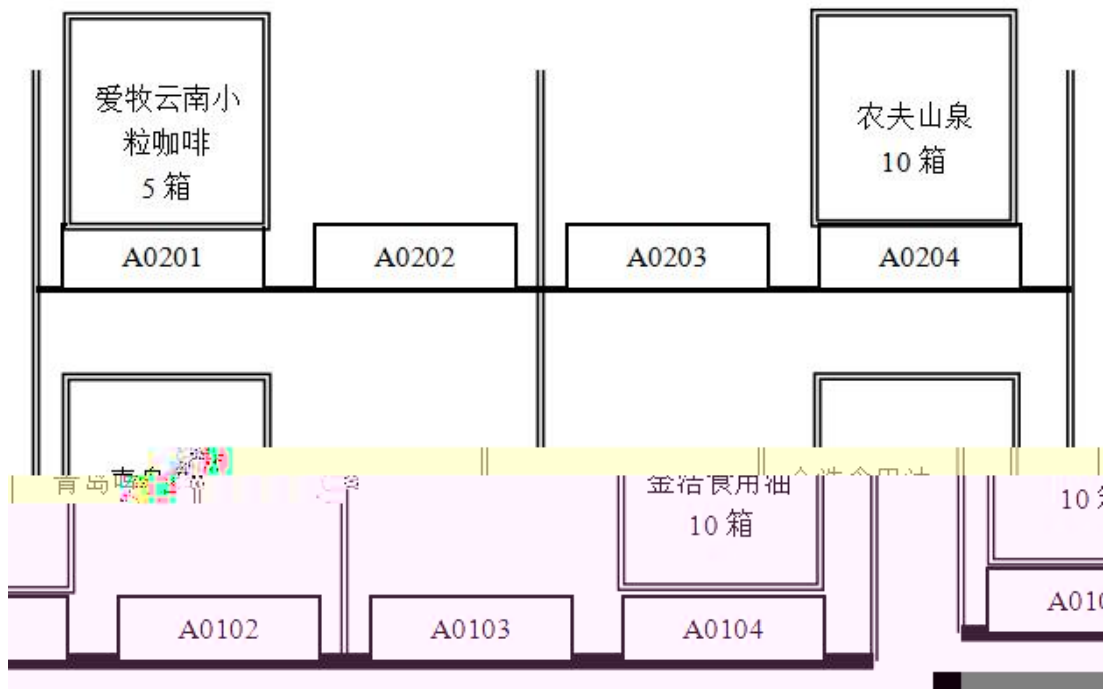

○  
km

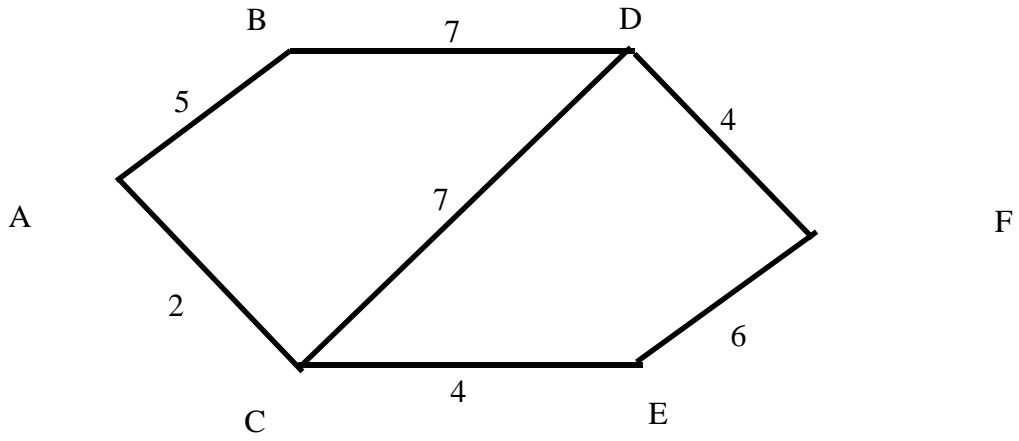

○



	5			0
	10			
	5			
	5			
	5			
	5			
	15			

		10			
		10			
		20			
		10			

**1**

---

--	--	--	--	--	--

---



---

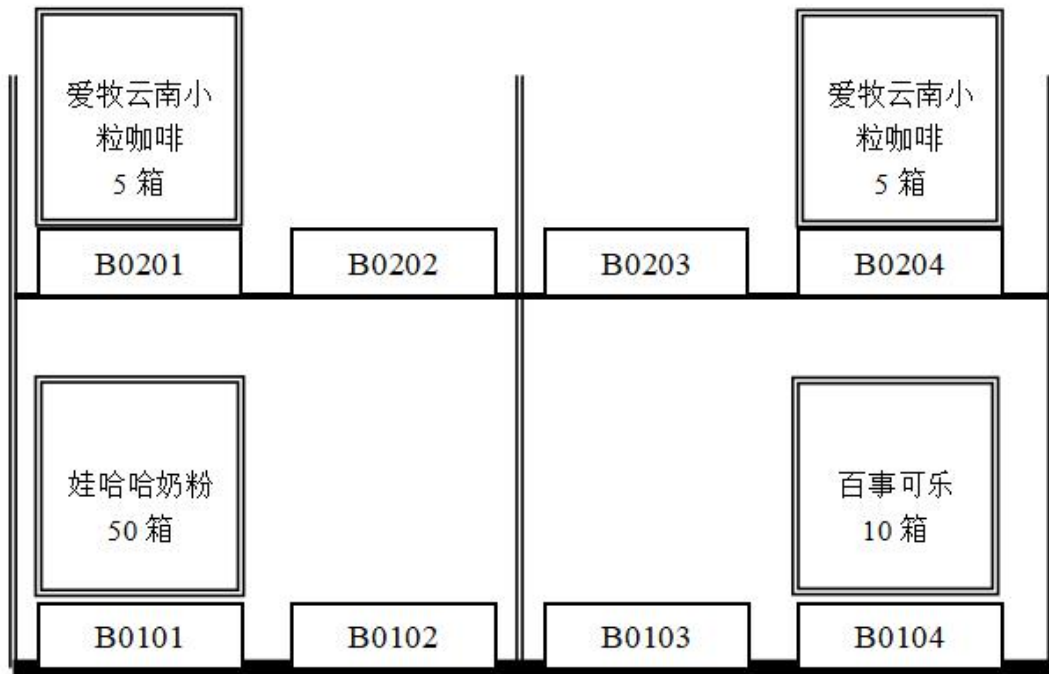
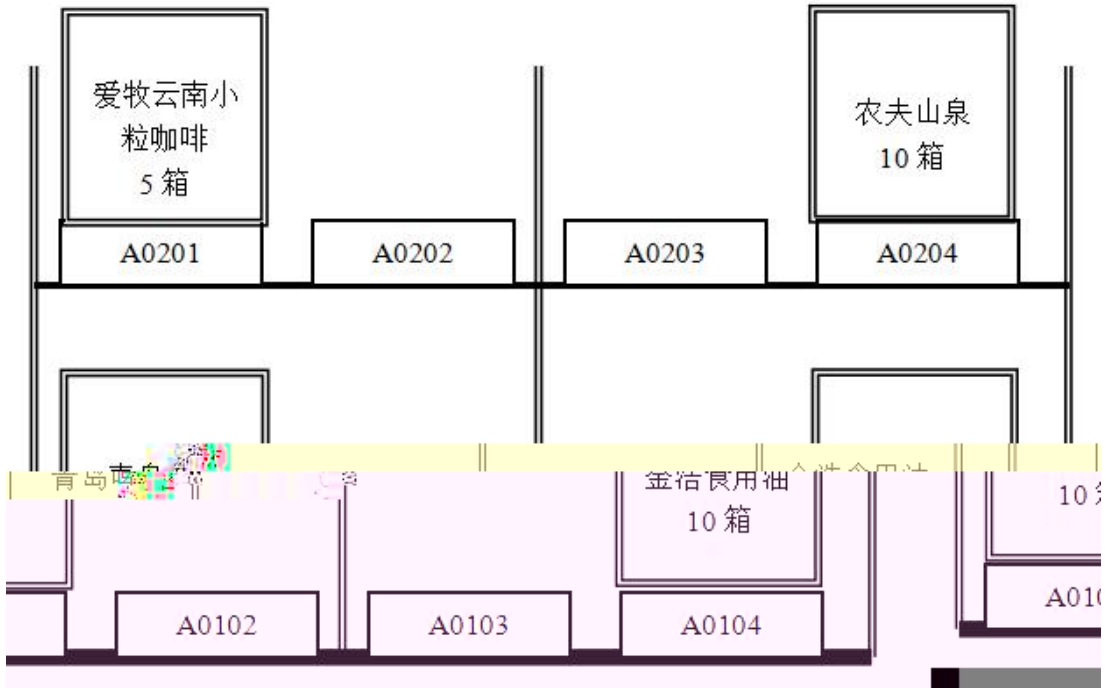



km

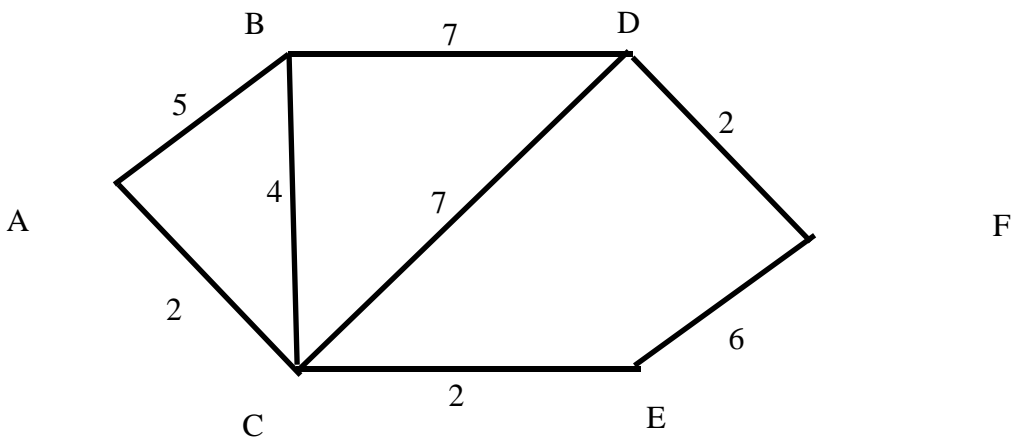

		5		
		10		
		5		0
		5		
		5		



		5			
		15			
		10			
		10			
		20			
		10			





○

○



	5		1	2 2
	10		2	1 2 1 2
	5		1	2 2
	30			0
	15			
	5			
	20			

		10			







○

○



	5		1	2 2
	10		2	1 2 1 2 2
	5		1	2 2
	30			0
	15			
	5			
20				

		10			







○

○



	5		1	2 2
	10		2	1 2 2 1 2
	5		1	2 2
	30			0
	15			
5				
20				

		10			







○

○

--	--





	5		1	2	
	10			1	
				2	2
5			2	2	
			1	0	
	30				
	15				
5					
20					

		10			





○

○



5

		10			



### 三、国际物流作业组织与管理模块

AÑÑ)

十一

0. P. 9  
151

KAÑÑ

○



---

---

---

---

---

**AGE BOND!**





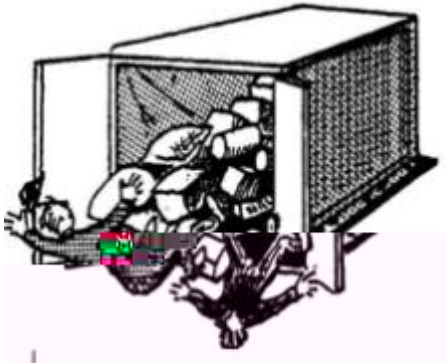
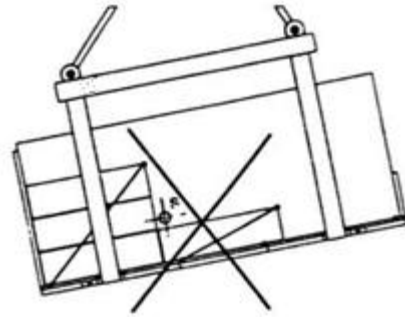





○

船公司	船名/航次	服务代码	航线	装船港/卸船港	启-达日期	天	挂港
Carrier			Lane	Load/Unload Port	ETD-ETA		Day
MSC	地中海航运	MASTER	中国-香港	HONG KONG 香港	02/25 (二)		
船名	意大利快线	409E		KAOHSIUNG 高雄	03/15 (六)		
船名	NYK	ITALIAN EXPRES	中国-东南亚	HONG KONG 香港	02/25 (二)		
船名	日本邮船	S/024		BANGKOK 曼谷	03/02 (日)		
船名	CMA-CGM	CMA CGM GEMINI	中国-非洲	XIAMEN 厦门	02/25 (二)		
船名	达飞轮船	EXA49E		DURBAN 德班	03/27 (四)		
船名	KLINE	HYUNDAI PLATINUM	中国-中澳美	SHANGHAI 上海	02/25 (二)		
船名	川崎汽船	M/004W		PARANAGUA 巴拉那瓜	04/09 (三)		
船名	DMS	COSCO KAOHSIUNG	中国-澳新	HONG KONG 香港	02/25 (二)		
船名	达飞轮船	G/GFS46E		NOUMEA 努美阿	04/02 (三)		
船名	RCL	ROTA PERMASAN	中国-中东/波斯湾/印巴	QINGDAO 青岛	02/28 (五)		
船名	招商局	VPM114		MADRAS 马德拉斯	03/18 (二)		
船名	ZIM	KUO HUNG	CHINA_VIETNAM (CVX)	NINGBO 宁波	02/25 (二)		
船名	以星轮船	311		HONG KONG 香港	03/15 (六)		
船名	SAPMARINE	HEINE P	中国-非洲	KAOHSIUNG 高雄	02/25 (二)		
船名	比利时南航	1404		MINDELO	04/05 (六)		
船名	CSAV	CAP SAN NICOLA	中国-中澳美	SHANGHAI 上海	02/25 (二)		
船名	南澳船	S/01409		RIO GRANDE 里奥格兰德	04/07 (一)		
船名	OOCL	DRESDEN EXPRES	Pacific Atlantic (PAX)	SHANGHAI 上海	02/25 (二)		
船名	东方海外	S/16808		HALIFAX 哈利法克斯	04/14 (一)		



○  
○



				0

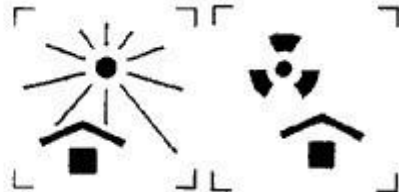

○

				0



○

○













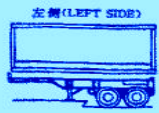
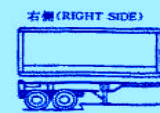

集装箱设备交接单  
EQUIPMENT INTERCHANGE RECEIPT

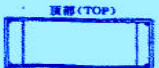
OUT 出场

用箱人/运箱人 (CNTR. USER/HAULIER)		提箱地点 (PLACE OF DELIVERY)	
发往地点 (DELIVERED TO)		返回/收箱地点 (PLACE OF RETURN)	
船名/航次 (VESSEL/VOYAGE No.)	集装箱号 (CNTR. No.)	尺寸/类型 (SIZE/TYPE)	营运人 (CNTR. OPTR)
箱号 (CNTR. No.)	箱号 (CNTR. No.)	箱封号 (SEAL No.)	箱封号 (SEAL No.)
空重 (CMTD W.)	进箱日期/状态 (PPS OF GATE OUT STATUS)	进箱日期/状态 (PPS OF GATE IN STATUS)	出箱日期 (TIME OUT)
交换地点记录 (DISCRETION AT THE TIME OF INTERCHANGE)			
普通集装箱 (GEN. CNTR.)	冷藏集装箱 (REF. CNTR.)	特种集装箱 (SPL. CNTR.)	发电机 (GEN. SET)
<input type="checkbox"/> 正常 (SOUND) <input type="checkbox"/> 异常 (DEFECTIVE)	<input type="checkbox"/> 正常 (SOUND) 设定温度 (SET) <input type="checkbox"/> 异常 (DEFECTIVE) 记录温度 (RECORDED)	<input type="checkbox"/> 正常 (SOUND) <input type="checkbox"/> 异常 (DEFECTIVE)	<input type="checkbox"/> 正常 (SOUND) <input type="checkbox"/> 异常 (DEFECTIVE)
损坏记录及代号 (DAMAGE CODE)			
<div style="display: flex; justify-content: space-around;"> <div style="text-align: center;">               破损 (BROKEN)         </div> <div style="text-align: center;">               凹痕 (DENT)         </div> <div style="text-align: center;">               丢失 (MISSING)         </div> <div style="text-align: center;">               污损 (DIRTY)         </div> <div style="text-align: center;">               危标 (DGLABEL)         </div> </div>			
<div style="display: flex; justify-content: space-around;"> <div style="text-align: center;">               左侧 (LEFT SIDE)         </div> <div style="text-align: center;">               右侧 (RIGHT SIDE)         </div> <div style="text-align: center;">               前部 (FRONT)         </div> <div style="text-align: center;">               内部 (INSIDE)         </div> </div>		如有异状, 请注明程度及尺寸 (REMARK)	
<div style="display: flex; justify-content: space-around;"> <div style="text-align: center;">               顶部 (TOP)         </div> <div style="text-align: center;">               底部 (FLOOR BASE)         </div> <div style="text-align: center;">               后部 (REAR)         </div> </div>			
除列明者外, 集装箱设备交接时完好无损, 铅封完整无误。 INTERCHANGED IN SOUND CONDITION AND SEAL INTACT UNLESS OTHERWISE STATED 码头/堆场值班员签署 (TERMINAL/DEPOT CLERK'S SIGNATURE)			
_____ 年 _____ 月 _____ 日 GB/T 18561—1996 格式印制		CONTAINER EQUIPMENT 用箱人/运箱人签署 (CONTAINER USER/HAULIER'S SIGNATURE) _____ 年 _____ 月 _____ 日	

				0







				0

--	--	--	--	--	--



				0



				0



				0







--	--	--

				0

--	--	--	--	--	--





--	--	--	--	--	--

--	--	--	--	--	--	--	--

○







				0





				0







					0

○

--	--	--

				0



				0





				0

--	--	--	--	--	--

○

○

○

0

○

				0



				0

#### 四、 快递物流作业组织与管理模块





















--	--	--	--	--	--

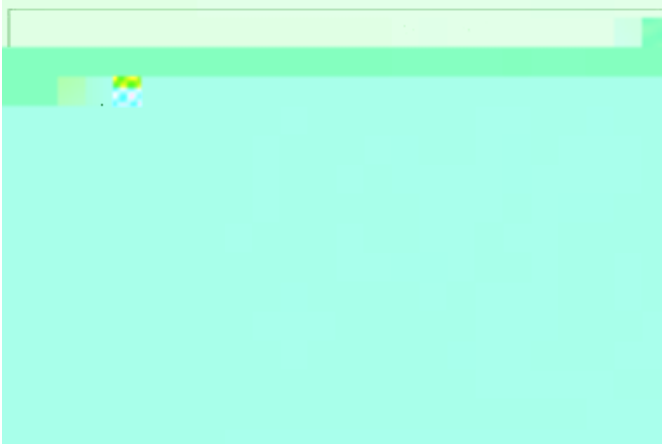
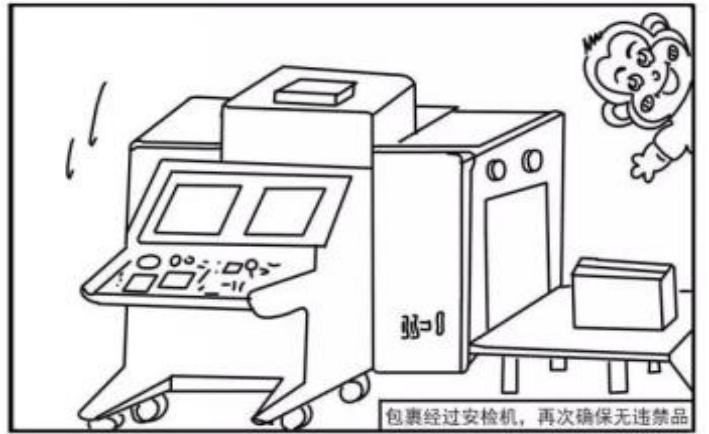



--	--	--	--	--	--



















--	--	--	--	--	--



[想知道:中国成都理工大学校园快递具体在哪? 百度知道](#)

3个回答 - 提问时间: 2014年02月10日

**最佳答案**  [1735363636](#) 顺丰, 圆通, 中通, 申通, 申通在图书馆下面, 常用的是顺丰。

[http://www.baidu.com/question/1352111111111111111.html](#)



















--	--	--	--















--	--	--	--











































































--

